



MANUALS & DOCUMENTS
SPARE PARTS

SET 2

SHOCK HARDWARE KIT 16
REF. 099.22200

SUMMUM CARBON 2022-2023



SAFETY AND GENERAL INSTRUCTIONS

Please, be aware that the following 3 icons may appear in this technical guide. Each one indicates to take the following precautions:

WARNING!

Not keeping to the indications or following unsafe practices may result in serious injuries or even death. The tasks involve technical difficulty and if they are badly developed, they could damage your bicycle or result in a void warranty.

CAUTION

Not keeping to the indications or following unsafe practices may result in light injuries. The tasks involve technical difficulty and if they are badly developed, they could damage your bicycle or result in a void warranty.

INFORMATION

Information which is essential for a proper execution of the task and therefore, avoid any possible damage to your bicycle or losing the warranty, but does not involve any risk for the person.

CONSIDERATIONS

- Using non-original spare parts may result in damage, malfunctions and accidents which may lead to severe consequences.
- Please note that to perform some of the steps described in this manual, skills beyond the average bicycle user are required. In the event of not being qualified to follow any of these steps, please take your bicycle to a Mondraker authorized technical service for maintenance and replacement of its components. The incorrect installation of spare parts can result in malfunctions, accidents, injuries, and warranty void.



SET 2

SHOCK HARDWARE KIT 16

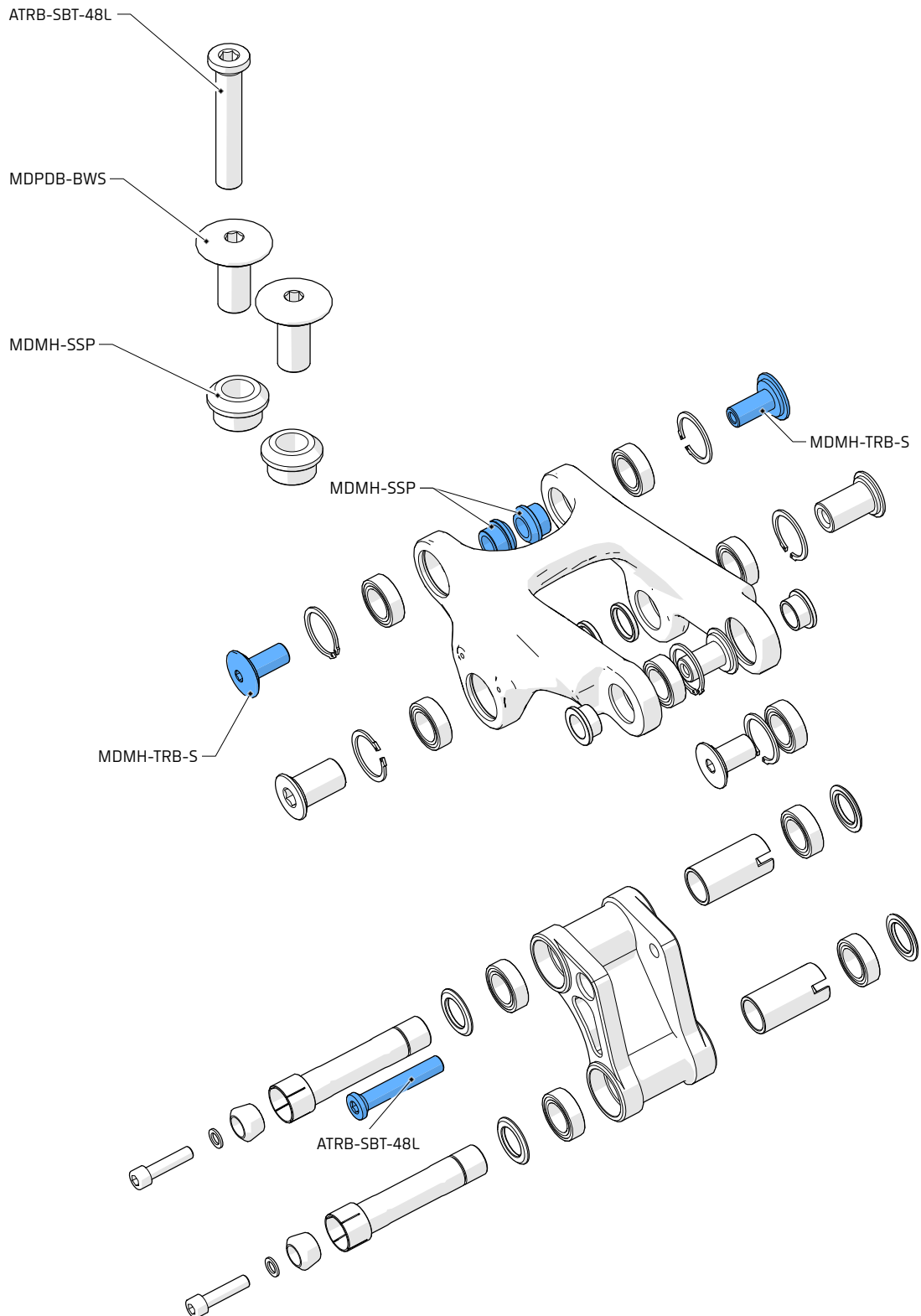



LUBRICATION & THREAD LOCKER

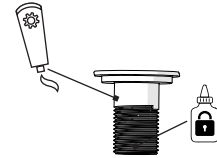
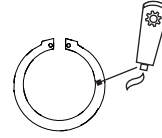
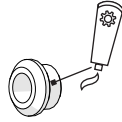
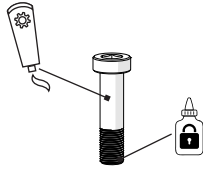

TOOLS



MEDIUM
STRENGTH
THREADLOCKER



SOFT-BRISTLED BRUSH



GLOVES



GREASE



NEUTRAL DEGREASER



HEX KEY 5



SAFETY GOGGLES

TOOLS AND TIGHTENING TORQUES



PHILIPS SCREWDRIVER



TORX KEY



ALLEN KEY



SPANNER

These symbols indicate tool type and size, as well as the tightening torque in Newtons per meter, e.g.  10 N.m

CLEANING

- Once the pieces are disassembled, it is recommended to **clean**, **grease**, and **put thread locker** (if necessary) on the components which are going to be re-used.



UPPER LINK INSTALLATION GUIDE

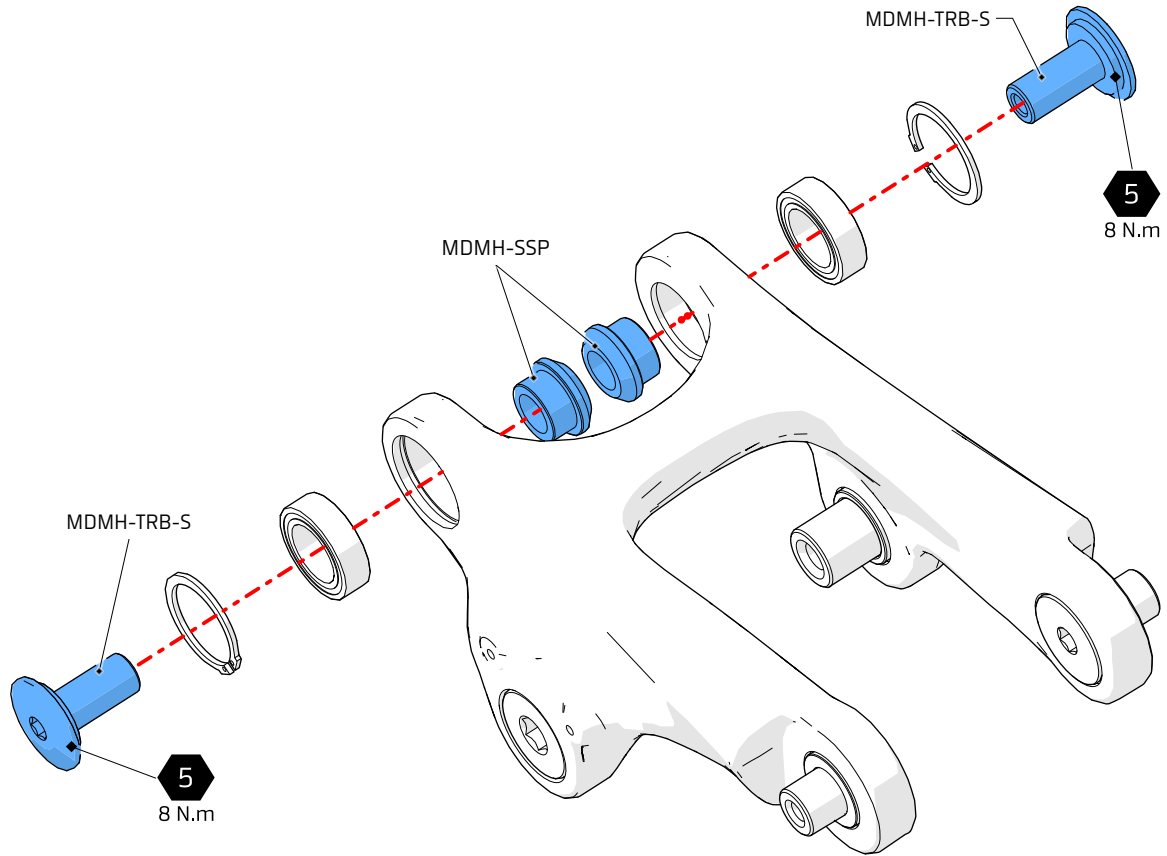

LOWER LINK INSTALLATION GUIDE

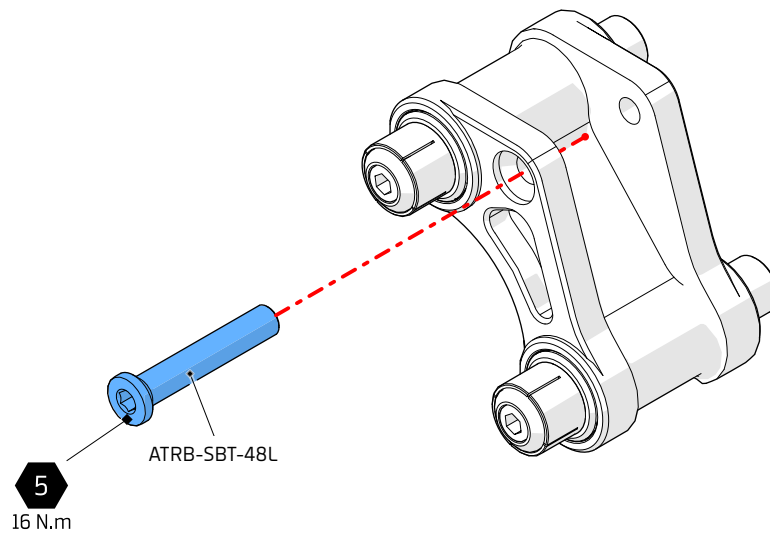



All information and pictures on this document are provided for information purposes only and do not constitute a legal contract between Mondraker and any person or entity. Specifications, geometries or any other technical information published are subject to change without prior notice.

© All trademarks and models are property of Blue Factory Team, S.L.U. and are protected by current laws and applicable international agreements.